



NEW PRODUCT

新产品



NEW PRODUCT

Chain Swivels G-401 旋转环 G-401

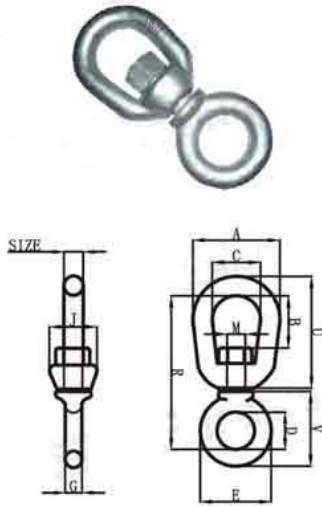

| Size (in) | Dimensions(in.) | | | | | | | | | | | WLL (lbs) | Weight (lbs) |
|-----------|-----------------|------|------|------|------|------|------|------|------|------|------|-----------|--------------|
| | A | B | C | D | E | G | J | M | R | U | V | | |
| 1/4 | 1.25 | 0.69 | 0.75 | 0.62 | 1.12 | 0.25 | 0.69 | 0.31 | 2.25 | 1.69 | 1.25 | 850 | 0.13 |
| 5/16 | 1.63 | 0.81 | 1.00 | 0.75 | 1.38 | 0.31 | 0.81 | 0.38 | 2.72 | 2.06 | 1.47 | 1,250 | 0.25 |
| 3/8 | 2.00 | 0.94 | 1.25 | 1.00 | 1.75 | 0.38 | 1.00 | 0.50 | 3.44 | 2.50 | 1.88 | 2250 | 0.54 |
| 1/2 | 2.50 | 1.31 | 1.50 | 1.25 | 2.25 | 0.50 | 1.31 | 0.63 | 4.25 | 3.19 | 2.44 | 3,600 | 1.12 |
| 5/8 | 3.00 | 1.56 | 1.75 | 1.50 | 2.75 | 0.62 | 1.50 | 0.75 | 5.13 | 3.88 | 2.94 | 5,200 | 2.09 |
| 3/4 | 3.50 | 1.75 | 2.00 | 1.75 | 3.25 | 0.75 | 1.88 | 0.88 | 5.78 | 4.94 | 3.46 | 7,200 | 3.09 |

Regular Swivels G-402 旋转环 G-402

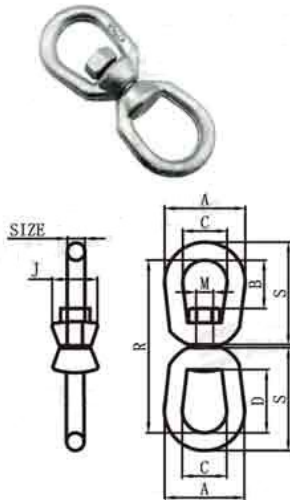

| Size (in) | Dimensions(in) | | | | | | | | WLL (lbs) | Weight (lbs) |
|-----------|----------------|------|------|------|------|------|-------|------|-----------|--------------|
| | A | B | C | D | J | M | R | S | | |
| 1/4 | 1.25 | 0.69 | 0.75 | 1.06 | 0.69 | 0.31 | 2.94 | 1.69 | 850 | 0.21 |
| 5/16 | 1.63 | 0.81 | 1 | 1.25 | 0.81 | 0.38 | 3.56 | 2.06 | 1,250 | 0.39 |
| 3/8 | 2 | 0.94 | 1.25 | 1.5 | 1 | 0.5 | 4.31 | 2.5 | 2,250 | 0.71 |
| 1/2 | 2.5 | 1.31 | 1.5 | 2 | 1.31 | 0.63 | 5.44 | 3.19 | 3,600 | 1.32 |
| 5/8 | 3 | 1.56 | 1.75 | 2.38 | 1.5 | 0.75 | 6.56 | 3.88 | 5,200 | 2.49 |
| 3/4 | 3.5 | 1.75 | 2 | 2.63 | 1.88 | 0.88 | 7.19 | 4.31 | 7,200 | 4.02 |
| 7/8 | 4 | 2.06 | 2.25 | 3.06 | 2.13 | 1 | 8.38 | 5 | 10,000 | 6.25 |
| 1 | 4.5 | 2.31 | 2.5 | 3.5 | 2.38 | 1.13 | 9.63 | 5.75 | 12,500 | 8.95 |
| 1 1/4 | 5.63 | 2.69 | 3.13 | 3.69 | 3 | 1.5 | 11.44 | 6.75 | 18,000 | 16.37 |
| 1 1/2 | 7.09 | 3.88 | 4.09 | 3.88 | 3.75 | 2.25 | 16.69 | 9.91 | 45,200 | 45.79 |

Jaw End Swivels G-403 旋转环 G-403

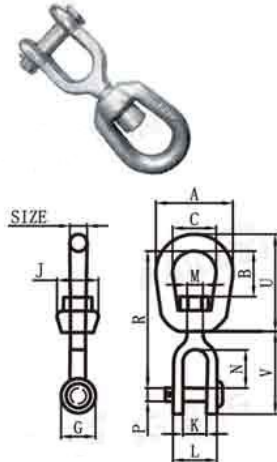

| Size (in) | Dimensions(in) | | | | | | | | | | | | | W.L.L (lbs) | Weight (lbs) |
|-----------|----------------|------|------|------|------|------|------|------|------|------|-------|------|-------|-------------|--------------|
| | A | B | C | G | J | K | L | M | N | P | R | U | V | | |
| 1/4 | 1.25 | 0.69 | 0.75 | 0.69 | 0.69 | 0.47 | 1.03 | 0.31 | 0.88 | 0.25 | 2.63 | 1.69 | 1.69 | 850 | 0.21 |
| 5/16 | 1.63 | 0.81 | 1 | 0.81 | 0.81 | 0.5 | 1.13 | 0.38 | 0.88 | 0.31 | 2.94 | 2.06 | 1.81 | 1,250 | 0.34 |
| 3/8 | 2 | 0.94 | 1.25 | 1 | 1 | 0.63 | 1.41 | 0.5 | 1.06 | 0.38 | 3.63 | 2.5 | 2.25 | 2,250 | 0.66 |
| 1/2 | 2.5 | 1.31 | 1.5 | 1.31 | 1.31 | 0.75 | 1.75 | 0.63 | 1.31 | 0.5 | 4.5 | 3.19 | 2.88 | 3,600 | 1.34 |
| 5/8 | 3 | 1.56 | 1.75 | 1.63 | 1.5 | 0.94 | 2.06 | 0.75 | 1.5 | 0.63 | 5.31 | 3.88 | 3.44 | 5,200 | 2.48 |
| 3/4 | 3.5 | 1.75 | 2 | 1.88 | 1.88 | 1.13 | 2.53 | 0.88 | 1.75 | 0.75 | 6.06 | 4.31 | 4 | 7,200 | 3.88 |
| 7/8 | 4 | 2.06 | 2.25 | 2.13 | 2.13 | 1.19 | 2.75 | 1 | 2.06 | 0.88 | 7 | 5 | 4.53 | 10,000 | 5.87 |
| 1 | 4.5 | 2.31 | 2.5 | 2.63 | 2.38 | 1.75 | 3.72 | 1.13 | 2.81 | 1.13 | 8.56 | 5.75 | 5.94 | 12,500 | 9.84 |
| 1 1/4 | 5.69 | 2.69 | 3.13 | 3.13 | 3 | 2.06 | 4.31 | 1.63 | 2.81 | 1.38 | 9.75 | 7.06 | 6.38 | 18,000 | 15.75 |
| 1 1/2 | 7 | 3.88 | 4 | 5.63 | 4 | 2.88 | 6 | 2.25 | 4.44 | 2.25 | 14.25 | 10 | 10.84 | 45,200 | 54.75 |

European Type Connecting Links 欧式双环扣

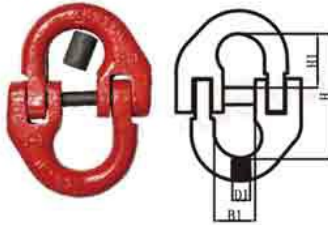

| Size (mm) | WLL (t) | Dimensions(mm) | | | | Weight (lbs) |
|-----------|---------|----------------|------|------|------|--------------|
| | | B1 | D1 | H1 | H | |
| 6-8 | 1 | 14.5 | 7 | 18.5 | 47.5 | 0.3 |
| 7/8-8 | 2 | 20.5 | 8.5 | 22 | 57 | 0.35 |
| 10-8 | 3.2 | 25.7 | 11 | 26.5 | 69 | 0.75 |
| 13-8 | 5.1 | 26.5 | 15.5 | 32 | 86 | 1.43 |
| 16-8 | 8 | 33 | 19.5 | 39.5 | 103 | 2.2 |
| 18/20-8 | 12.6 | 41.5 | 22 | 46 | 122 | 3.93 |
| 22-8 | 15 | 47 | 25 | 53 | 138 | 4.6 |
| 24/26-8 | 20.6 | 59 | 29 | 59 | 152 | 7.8 |
| 30/32-8 | 32.2 | 68 | 36 | 68 | 176 | 15 |

US Type Connecting Links A-337 美式双环扣 A-337

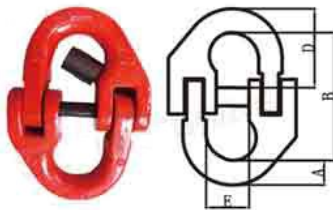

| Size (in) | WLL(lbs) | Dimensions(in) | | | | Weight(lbs) |
|-----------|----------|----------------|------|------|------|-------------|
| | | A | B | D | E | |
| 1/4 | 3,600 | 0.36 | 1.88 | 0.78 | 0.66 | 0.28 |
| 5/16 | 4,500 | 0.39 | 2.13 | 0.88 | 0.69 | 0.33 |
| 3/8 | 7,100 | 0.52 | 2.5 | 1.03 | 0.88 | 0.73 |
| 1/2 | 12,000 | 0.64 | 3.44 | 1.44 | 1.13 | 1.67 |
| 5/8 | 18,100 | 0.75 | 4.13 | 1.73 | 1.41 | 2.86 |
| 3/4 | 28,300 | 0.97 | 4.94 | 2.06 | 1.63 | 5 |
| 7/8 | 34,200 | 1.06 | 5.50 | 2.31 | 2 | 7.5 |
| 1 | 47,700 | 1.22 | 6.00 | 2.50 | 2.25 | 11.03 |
| 1 1/4 | 72,300 | 1.50 | 7.43 | 3.06 | 2.56 | 20.38 |

NEW PRODUCT

D-Rings D型环



| Size A×B×D (in) | Dimensions(mm) | | M.B.S. (lbs) | Weight (lbs) |
|-----------------------|----------------|------|-----------------|-----------------|
| | L | C | | |
| 21/4"×21/2"×1/2" | 44.8 | 15.5 | 12,000 | 0.94 |
| 3"×3"×5/8" | 63 | 23.4 | 18,000 | 1.88 |
| 3"×3"×3/4" | 63 | 25.4 | 26,500 | 2.70 |
| 3"×3"×1" | 64 | 30.8 | 47,000 | 4.21 |
| 3"×4"×1" | 64 | 30.8 | 47,000 | 4.74 |

Weldless Alloy Master Links 强力环

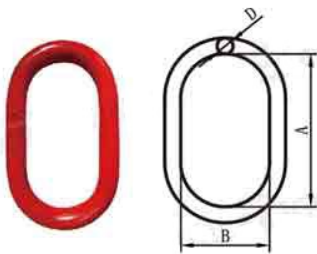

| Size (in) | Dimensions(mm) | | | Working Load Limit Single Pull(t) | Weight (lbs) |
|--------------|----------------|------|------|---|-----------------|
| | A | B | D | | |
| 1/2 | 127 | 63.5 | 13 | 2 | 0.88 |
| 5/8 | 152 | 76 | 16 | 3 | 1.54 |
| 3/4 | 140 | 70 | 19 | 4.7 | 2.31 |
| 7/8 | 160 | 90 | 22 | 6.4 | 3.24 |
| 7/8 | 178 | 89 | 22 | 8 | 3.46 |
| 1 | 178 | 89 | 25 | 11 | 4.63 |
| 1 1/4 | 222 | 110 | 32 | 16 | 9.35 |
| 1 1/2 | 267 | 135 | 38 | 21.7 | 16.07 |
| 1 3/4 | 305 | 152 | 45 | 28.4 | 25.44 |
| 2 | 350 | 190 | 50 | 35 | 36.46 |
| 2 | 350 | 190 | 50 | 45 | 36.46 |
| 2.5 | 406 | 203 | 63.5 | 50 | 68.12 |

Weldless Rings 圆环

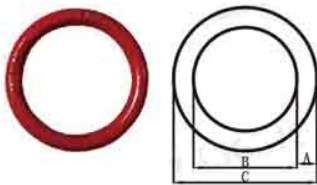

| Size (A) (in) | Dimensions(in) | | WLL(lbs) | Weight (lbs) |
|------------------|----------------|------|----------|-----------------|
| | B | C | | |
| 7/8*4 | 4 | 5.75 | 7200 | 2.72 |
| 7/8*5 1/2 | 5.5 | 7.25 | 5600 | 3.47 |
| 1*4 | 4 | 6 | 10800 | 3.69 |
| 1 1/8*6 | 6 | 8.25 | 10400 | 6.6 |
| 1 1/4*5 | 5 | 7.5 | 17000 | 6.82 |
| 1 3/8*6 | 6 | 8.75 | 19000 | 10.12 |

Weldless Sling Links 梨形环

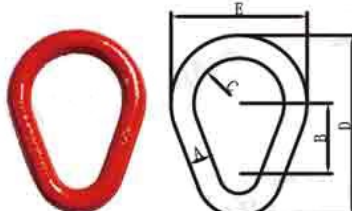

| Size (in) | WLL (lbs) | Dimensions (in) | | | | | Weight (lbs) |
|-----------|-----------|-----------------|------|-------|------|------|--------------|
| | | A | B | C | D | E | |
| 3/8 | 1800 | 0.38 | 0.75 | 3 | 2.25 | 1.13 | 0.23 |
| 1/2 | 2900 | 0.5 | 1 | 4 | 3 | 1.5 | 0.55 |
| 5/8 | 4200 | 0.63 | 1.25 | 5 | 3.75 | 1.87 | 1.06 |
| 3/4 | 6000 | 0.75 | 1.5 | 6 | 4.5 | 2.25 | 1.88 |
| 7/8 | 8300 | 0.88 | 1.75 | 7 | 5.25 | 2.63 | 2.75 |
| 1 | 10800 | 1 | 2 | 8 | 6 | 3 | 4.35 |
| 1 1/4 | 16750 | 1.25 | 2.5 | 10.25 | 7.5 | 4 | 7.6 |
| 1 3/8 | 20500 | 1.38 | 2.75 | 11 | 8.25 | 4.13 | 11.3 |

Twin Clevis Links S-249 羊角双环 S-249

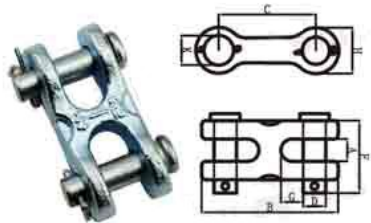

| Size (in) | WLL (lbs) | Dimensions (in) | | | | | | | | Weight (lbs) |
|-----------|-----------|-----------------|------|------|------|------|------|------|------|--------------|
| | | A | B | C | D | F | G | H | K | |
| 1/4-5/16 | 4700 | 0.47 | 2.5 | 1.56 | 0.38 | 1.31 | 0.43 | 0.94 | 0.5 | 0.31 |
| 3/8 | 6600 | 0.53 | 2.81 | 1.81 | 0.44 | 1.53 | 0.50 | 1 | 0.56 | 0.44 |
| 7/16-1/2 | 11300 | 0.65 | 3.62 | 2.31 | 0.56 | 1.91 | 0.63 | 1.31 | 0.81 | 0.98 |

Double Clevis Links S-247 羊角双环 S-247

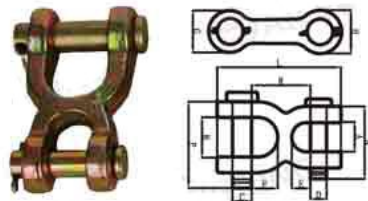

| Size (in) | WLL (lbs) | Dimensions (in) | | | | | | | | | | | | Weight (lbs) |
|-----------|-----------|-----------------|------|------|------|------|------|------|------|------|------|------|------|--------------|
| | | A | B | C | D | E | F | G | H | L | N | P | R | |
| 1/4 | 2600 | 0.5 | 0.75 | 0.5 | 0.31 | 0.38 | 0.75 | 1 | 0.81 | 2.81 | 1.38 | 1.66 | 1.5 | 0.38 |
| 5/16-3/8 | 5400 | 0.56 | 1 | 0.63 | 0.44 | 0.47 | 1 | 1.19 | 1 | 3.53 | 1.75 | 2.25 | 1.91 | 0.81 |
| 7/16 | 7200 | 0.69 | 1.13 | 0.69 | 0.56 | 0.59 | 1.09 | 1.31 | 1.19 | 4.06 | 2 | 2.5 | 2.19 | 1.25 |
| 1/2 | 9200 | 0.81 | 1.25 | 0.75 | 0.63 | 0.68 | 1.25 | 1.44 | 1.31 | 4.53 | 2.25 | 2.75 | 2.47 | 1.56 |

NEW PRODUCT

Standard Wire Rope Thimbles G-411 美式套环 G-411

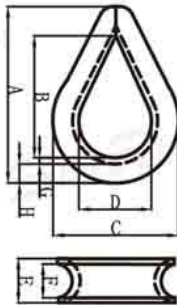

| Size | | Dimensions(in) | | | | | | | | Weight 100pcs (lbs) |
|-------------|-------|----------------|------|------|------|------|------|------|------|---------------------------|
| (in) | (mm) | A | B | C | D | E | F | G | H | |
| 1/8 | 3-4 | 1.94 | 1.31 | 1.06 | 0.69 | 0.25 | 0.16 | 0.05 | 0.13 | 3.5 |
| 3/16 | 5 | 1.94 | 1.31 | 1.06 | 0.69 | 0.31 | 0.22 | 0.05 | 0.13 | 3.5 |
| 1/4 | 6-7 | 1.94 | 1.31 | 1.06 | 0.69 | 0.38 | 0.28 | 0.05 | 0.13 | 3.5 |
| 5/16 | 8 | 2.13 | 1.5 | 1.25 | 0.81 | 0.44 | 0.34 | 0.05 | 0.13 | 4 |
| 3/8 | 9-10 | 2.38 | 1.63 | 1.47 | 0.94 | 0.53 | 0.41 | 0.06 | 0.16 | 6.7 |
| 1/2 | 11-13 | 2.75 | 1.88 | 1.75 | 1.13 | 0.69 | 0.53 | 0.08 | 0.19 | 12.5 |
| 5/8 | 16 | 3.5 | 2.25 | 2.38 | 1.38 | 0.91 | 0.66 | 0.13 | 0.34 | 34.5 |
| 3/4 | 18-20 | 3.75 | 2.5 | 2.69 | 1.63 | 1.08 | 0.78 | 0.14 | 0.34 | 47.1 |
| 7/8 | 22 | 5 | 3.5 | 3.19 | 1.88 | 1.27 | 0.94 | 0.16 | 0.44 | 84.6 |
| 1 | 24-26 | 5.69 | 4.25 | 3.75 | 2.50 | 1.39 | 1.06 | 0.16 | 0.41 | 97.5 |
| 1 1/8-1 1/4 | 28-32 | 6.25 | 4.5 | 4.31 | 2.75 | 1.75 | 1.31 | 0.22 | 0.5 | 175 |

Extra Heavy Wire Rope Thimbles G-414 美式重型套环 G-414

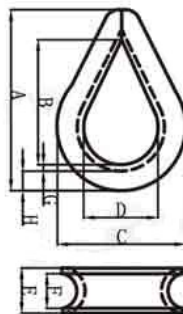

| Size | | Dimensions(in) | | | | | | | | Weight 100pcs (lbs) |
|-------------|-------|----------------|------|-------|------|------|------|------|------|---------------------------|
| (in) | (mm) | A | B | C | D | E | F | G | H | |
| 1/4 | 6-7 | 2.19 | 1.62 | 1.5 | 0.88 | 0.41 | 0.28 | 0.06 | 0.25 | 6.5 |
| 5/16 | 8 | 2.5 | 1.88 | 1.81 | 1.06 | 0.5 | 0.34 | 0.08 | 0.3 | 11.8 |
| 3/8 | 9-10 | 2.88 | 2.12 | 2.12 | 1.12 | 0.63 | 0.41 | 0.11 | 0.39 | 21.6 |
| 7/16 | 11-12 | 3.25 | 2.38 | 2.38 | 1.25 | 0.72 | 0.47 | 0.12 | 0.45 | 34.7 |
| 1/2-9/16 | 13-15 | 3.63 | 2.75 | 2.75 | 1.5 | 0.89 | 0.59 | 0.15 | 0.48 | 51 |
| 5/8 | 16 | 3.63 | 3.25 | 3.12 | 1.75 | 1 | 0.66 | 0.16 | 0.53 | 75.7 |
| 3/4 | 18-20 | 4.25 | 3.75 | 3.81 | 2 | 1.22 | 0.78 | 0.22 | 0.69 | 158.1 |
| 7/8 | 22 | 5.5 | 4.25 | 4.25 | 2.25 | 1.38 | 0.94 | 0.22 | 0.78 | 177.8 |
| 1 | 24-26 | 6.12 | 4.5 | 4.75 | 2.5 | 1.56 | 1.06 | 0.25 | 0.88 | 313.9 |
| 1 1/8-1 1/4 | 28-32 | 7 | 5.12 | 5.88 | 2.88 | 1.88 | 1.31 | 0.25 | 1.25 | 400 |
| 1 1/4-1 3/8 | 32-35 | 9.08 | 6.5 | 6.81 | 3.5 | 2.25 | 1.44 | 0.37 | 1.29 | 886 |
| 1 3/8-1 1/2 | 35-38 | 9 | 6.25 | 7.12 | 3.5 | 2.62 | 1.56 | 0.5 | 1.31 | 1294.8 |
| 1 5/8 | 40 | 11.25 | 8 | 8.12 | 4 | 3 | 1.72 | 0.5 | 1.38 | 1700 |
| 1 3/4 | 44 | 12.19 | 9 | 8.5 | 4.5 | 3.06 | 1.84 | 0.5 | 1.5 | 1775 |
| 1 7/8-2 | 48-52 | 15.12 | 12 | 10.38 | 6 | 3.38 | 2.09 | 0.5 | 1.69 | 2775 |
| 2-1/4 | 56 | 17.5 | 14 | 11.88 | 7 | 3.88 | 2.38 | 0.62 | 1.82 | 3950 |

Wire Rope Thimbles," A" ,DIN6899 德制DIN6899A套环

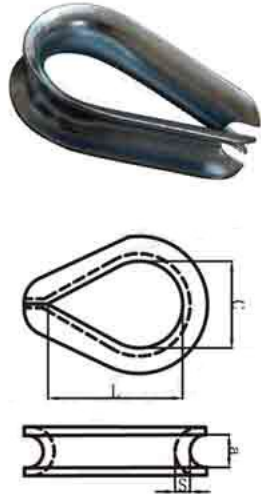

| Size(mm) | Dimensions(mm) | | | | | | | Weight 100pcs(lbs) |
|----------|----------------|-------|-----|----|-----|------|-----|-----------------------|
| | A | B | C | D | E | F | H | |
| 2.5 | 28 | 21.5 | 16 | 10 | 5 | 3 | 1 | 0.31 |
| 3 | 30 | 23.5 | 17 | 11 | 5.5 | 3.5 | 1 | 0.77 |
| 4 | 34 | 26.5 | 19 | 12 | 6 | 4 | 1 | 0.93 |
| 5 | 36 | 28 | 20 | 13 | 7 | 5 | 1 | 1.77 |
| 6 | 38 | 30 | 22 | 14 | 8 | 6 | 1 | 1.88 |
| 7 | 43 | 33 | 24 | 15 | 9 | 7 | 1.2 | 2.43 |
| 8 | 46 | 35 | 26 | 16 | 10 | 8 | 1.2 | 3.75 |
| 9 | 50 | 39 | 29 | 18 | 11 | 9 | 1.2 | 4.63 |
| 10 | 56 | 43 | 32 | 20 | 13 | 10 | 1.5 | 7.72 |
| 11 | 63 | 47.5 | 36 | 22 | 14 | 11 | 1.5 | 8.16 |
| 12 | 68 | 51.5 | 40 | 24 | 15 | 12 | 1.5 | 11.58 |
| 13 | 75 | 56.5 | 44 | 26 | 17 | 13 | 2 | 16 |
| 14 | 82 | 61 | 48 | 28 | 18 | 14 | 2 | 18.38 |
| 16 | 91 | 69.5 | 54 | 32 | 21 | 16.5 | 2.5 | 27.14 |
| 18 | 102 | 78 | 59 | 35 | 24 | 18 | 3 | 40.82 |
| 20 | 114 | 86.5 | 68 | 40 | 28 | 20 | 4 | 69.51 |
| 22 | 126 | 95 | 76 | 44 | 30 | 22 | 4 | 80.54 |
| 24 | 135 | 103.5 | 84 | 48 | 32 | 24 | 4 | 92.01 |
| 28 | 162 | 120.5 | 100 | 56 | 38 | 28 | 5 | 159.09 |

Wire Rope Thimbles," B" ,DIN6899 德制DIN6899B套环

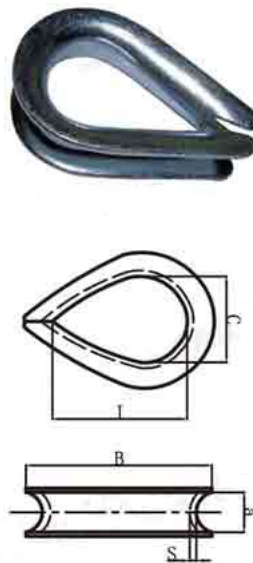

| Diameter rope (mm) | Dimensions(mm) | | | | | Weight 100 pcs(lbs) |
|--------------------------|-----------------|-------------------|------------------|--------------|-------------------|------------------------|
| | Groove width | Overall length | Inside length | Inside width | Back thickness | |
| | a | B | I | C | s | |
| 2.5 | 3 | 22 | 19 | 12 | 1.6 | 0.5 |
| 3.5 | 4 | 26 | 21 | 13 | 1.6 | 0.8 |
| 4 | 5 | 32 | 23 | 14 | 1.9 | 1 |
| 5 | 6 | 38 | 25 | 16 | 2.4 | 1.6 |
| 6 | 7 | 44 | 28 | 18 | 2.4 | 1.9 |
| 7 | 8 | 51 | 32 | 20 | 2.8 | 3 |
| 9 | 10 | 57 | 38 | 24 | 3.1 | 4.7 |
| 11 | 12 | 64 | 45 | 28 | 3.3 | 6.8 |
| 13 | 13 | 70 | 48 | 30 | 3.3 | 8 |
| 13 | 14 | 76 | 51 | 32 | 3.7 | 10 |
| 15 | 16 | 83 | 58 | 36 | 3.8 | 14.5 |
| 16 | 17 | 89 | 61 | 38 | 4.7 | 18 |
| 17 | 18 | 95 | 64 | 40 | 4.7 | 20 |
| 18 | 20 | 102 | 72 | 45 | 5.7 | 29 |
| 20 | 22 | 114 | 80 | 50 | 5.7 | 32 |
| 22 | 24 | 127 | 90 | 56 | 6.5 | 47 |
| 24 | 26 | 140 | 99 | 62 | 6.8 | 59 |
| 26 | 28 | 152 | 112 | 70 | 8 | 80 |
| 28 | 30 | 165 | 120 | 75 | 8 | 110 |
| 30 | 32 | 178 | 128 | 80 | 8 | 123 |
| 32 | 34 | 203 | 152 | 95 | 8.5 | 156 |
| 34 | 36 | 216 | 160 | 100 | 8.5 | 176 |
| 36 | 38 | 229 | 176 | 110 | 8.5 | 192 |
| 38 | 40 | 241 | 184 | 115 | 10.5 | 292 |
| 40 | 42 | 254 | 192 | 120 | 10.5 | 320 |
| 42 | 45 | 305 | 240 | 150 | 10.5 | 364 |

NEW PRODUCT

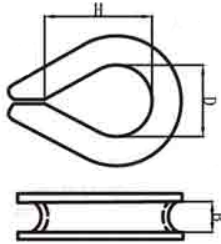

| Size(mm) | Dimensions(mm) | | | | | Weight 100PCS |
|----------|----------------|-----|----|----|----|------------------|
| | A | B | C | D | E | |
| 4 | 25 | 20 | 11 | 7 | 4 | 2.21 |
| 5 | 31 | 24 | 15 | 8 | 5 | 2.65 |
| 6 | 37 | 29 | 18 | 10 | 6 | 3.75 |
| 7 | 44 | 34 | 22 | 11 | 7 | 5.74 |
| 8 | 51 | 38 | 24 | 12 | 8 | 6.84 |
| 10 | 64 | 46 | 30 | 14 | 10 | 15 |
| 12 | 76 | 57 | 38 | 18 | 12 | 20.52 |
| 14 | 82 | 60 | 40 | 20 | 14 | 26.48 |
| 16 | 89 | 64 | 42 | 22 | 16 | 30.67 |
| 18 | 102 | 69 | 45 | 26 | 18 | 48.54 |
| 20 | 115 | 79 | 51 | 28 | 20 | 64.21 |
| 22 | 127 | 89 | 54 | 30 | 22 | 88.04 |
| 24 | 140 | 102 | 64 | 34 | 26 | 106.8 |
| 26 | 152 | 105 | 64 | 34 | 28 | 146.07 |
| 28 | 165 | 115 | 73 | 38 | 30 | 173.4 |
| 30 | 178 | 121 | 79 | 44 | 32 | 222.86 |
| 32 | 203 | 133 | 93 | 46 | 34 | 274.71 |

DIN 3091 Heavy Malleable Cast Ring 重型套环

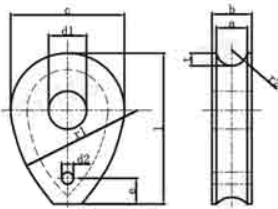

| Size (mm) | Dimensions(mm) | | | | | | | | |
|--------------|----------------|------|-----|----|------|-----|-----|----|----|
| | A | B | C | D1 | T | L | r1 | D2 | E |
| 8 | 9 | 15 | 40 | 14 | 4.5 | 56 | 48 | — | — |
| 10 | 11 | 17.5 | 50 | 18 | 6 | 70 | 60 | — | — |
| 12 | 13 | 20 | 60 | 21 | 7.5 | 84 | 72 | — | — |
| 14 | 16 | 23.5 | 70 | 25 | 9 | 98 | 84 | — | — |
| 16 | 18 | 26 | 80 | 28 | 10.5 | 110 | 96 | — | — |
| 18 | 20 | 28.5 | 90 | 31 | 12 | 130 | 110 | — | — |
| 20 | 22 | 31 | 100 | 35 | 13.5 | 140 | 120 | 10 | 30 |
| 22 | 24 | 33.5 | 110 | 38 | 15 | 150 | 130 | 10 | 30 |
| 24 | 26 | 36 | 120 | 41 | 16.5 | 170 | 140 | 10 | 30 |
| 26 | 29 | 39.5 | 130 | 44 | 18 | 180 | 160 | 10 | 30 |
| 28 | 31 | 42 | 140 | 47 | 20 | 200 | 170 | 10 | 30 |
| 32 | 35 | 47 | 160 | 53 | 23 | 220 | 190 | 10 | 30 |
| 36 | 40 | 53 | 180 | 59 | 26 | 250 | 220 | 10 | 30 |
| 40 | 44 | 58 | 200 | 65 | 29 | 280 | 240 | 10 | 30 |
| 44 | 48 | 63 | 220 | 70 | 32 | 310 | 260 | 15 | 45 |